

NPN EPITAXIAL SILICON TRANSISTOR FOR  
MICROWAVE AMPLIFICATION

## FEATURES

- High  $f_T$   
14 GHz TYP.
- High gain  
 $|S_{21e}|^2 = 14$  dB TYP.  
@  $f = 2$  GHz,  $V_{CE} = 3$  V,  $I_C = 10$  mA
- $NF = 1.3$  dB, @  $f = 2$  GHz,  $V_{CE} = 3$  V,  $I_C = 3$  mA
- 6-pin small mini mold package

ABSOLUTE MAXIMUM RATINGS ( $T_A = 25$  °C)

PARAMETER	SYMBOL	RATING	UNIT
Collector to Base Voltage	$V_{CBO}$	9	V
Collector to Emitter Voltage	$V_{CEO}$	6	V
Emitter to Base Voltage	$V_{EBO}$	2	V
Collector Current	$I_C$	30	mA
Total Power Dissipation	$P_T$	150	mW
Junction Temperature	$T_J$	150	°C
Storage Temperature	$T_{stg}$	-65 to +150	°C

## PACKAGE DIMENSION (in mm)

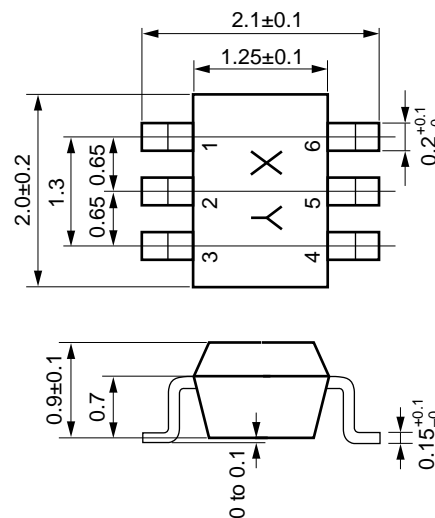

## PIN CONNECTIONS

- |            |              |
|------------|--------------|
| 1. Emitter | 4. Emitter   |
| 2. Emitter | 5. Emitter   |
| 3. Base    | 6. Collector |

**ELECTRICAL CHARACTERISTICS (T<sub>A</sub> = 25 °C)**

PARAMETER	SYMBOL	TEST CONDITIONS	MIN.	TYP.	MAX.	UNIT
Collector Cut-off Current	I <sub>CBO</sub>	V <sub>CB</sub> = 5 V, I <sub>E</sub> = 0			0.1	μA
Emitter Cut-off Current	I <sub>EBO</sub>	V <sub>EB</sub> = 1 V, I <sub>C</sub> = 0			0.1	μA
DC Current Gain	h <sub>FE</sub>	V <sub>CE</sub> = 3 V, I <sub>C</sub> = 10 mA <b>Note 1</b>	80		160	
Gain Bandwidth Product	f <sub>T</sub>	V <sub>CE</sub> = 3 V, I <sub>C</sub> = 10 mA, f = 2.0 GHz		14		GHz
Feed-back Capacitance	C <sub>re</sub>	V <sub>CB</sub> = 3 V, I <sub>E</sub> = 0, f = 1 MHz <b>Note 2</b>		0.15	0.25	pF
Insertion Gain	S <sub>21e</sub>   <sup>2</sup>	V <sub>CE</sub> = 3 V, I <sub>C</sub> = 10 mA, f = 2.0 GHz	12	14		dB
Noise Figure	NF	V <sub>CE</sub> = 3 V, I <sub>C</sub> = 3 mA, f = 2.0 GHz		1.3	2.3	dB

STANDARD SPECIFICATION	FB
Marking	T95
h <sub>FE</sub>	80 to 160

- Notes**
1. Pulse measurement: PW ≤ 350 μs, Duty cycle ≤ 2 %, Pulsed
  2. Measure by using 3-terminal bridge with emitter pin connected to guard terminal of bridge.

**TYPICAL CHARACTERISTICS (T<sub>A</sub> = 25 °C)**

**P<sub>T</sub> - T<sub>A</sub> CHARACTERISTICS**

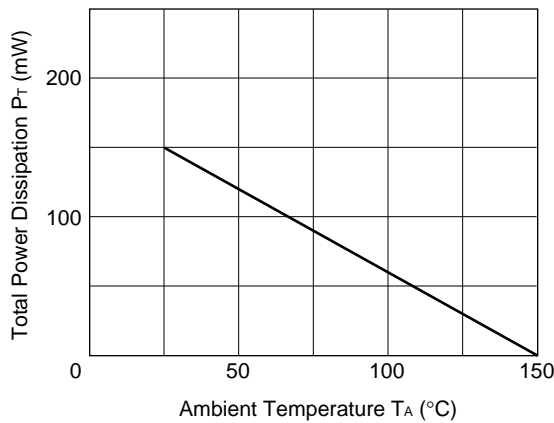

**I<sub>C</sub> - V<sub>BE</sub> CHARACTERISTICS**

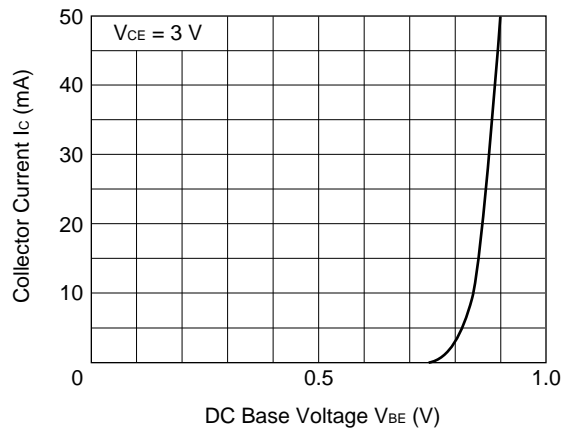

**I<sub>C</sub> - V<sub>CE</sub> CHARACTERISTICS**

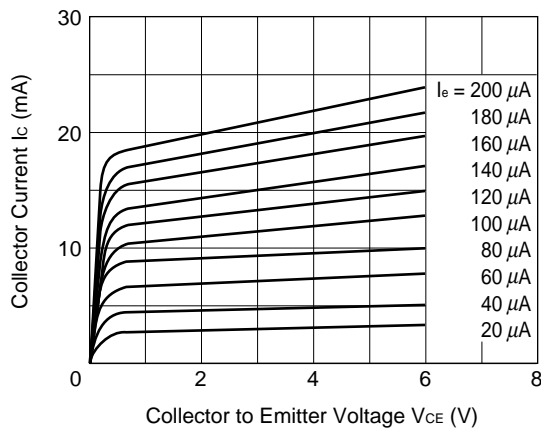

**h<sub>FE</sub> - I<sub>C</sub> CHARACTERISTICS**

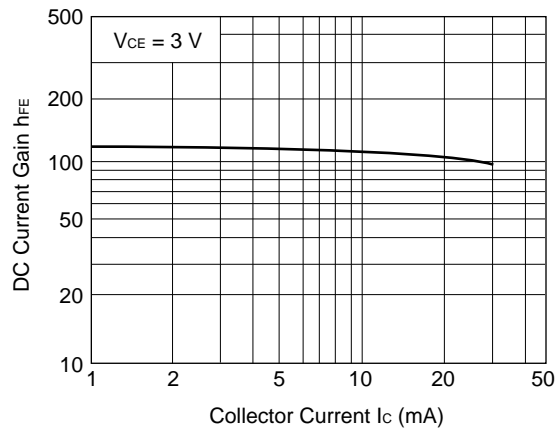

$f_T - I_C$  CHARACTERISTICS

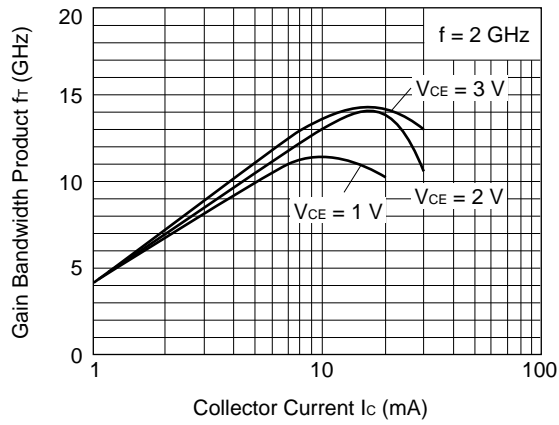

$|S_{21e}|^2 - I_C$  CHARACTERISTICS

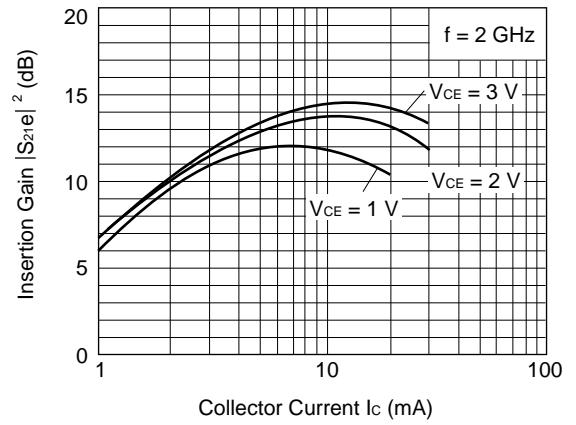

$N_F - I_C$  CHARACTERISTICS

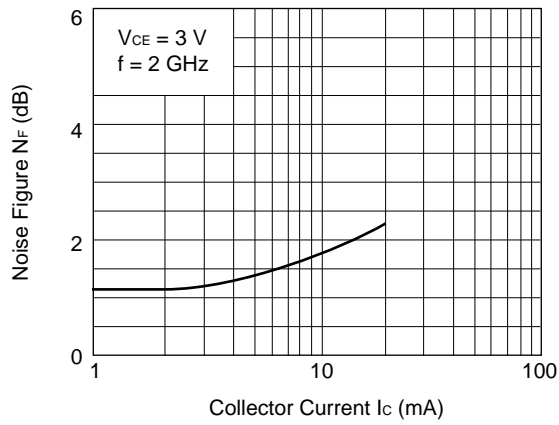

$|S_{21e}|^2 - f$  CHARACTERISTICS

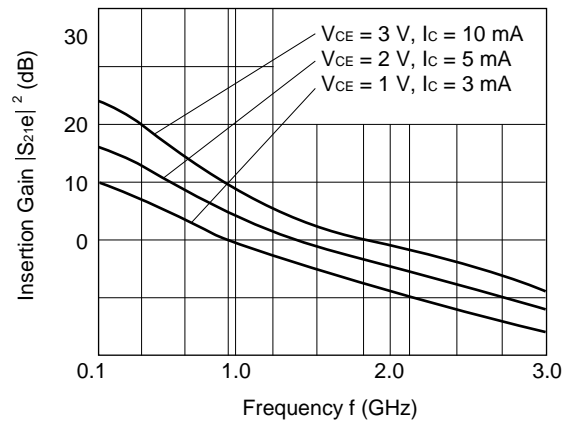

$C_{re} - V_{CB}$

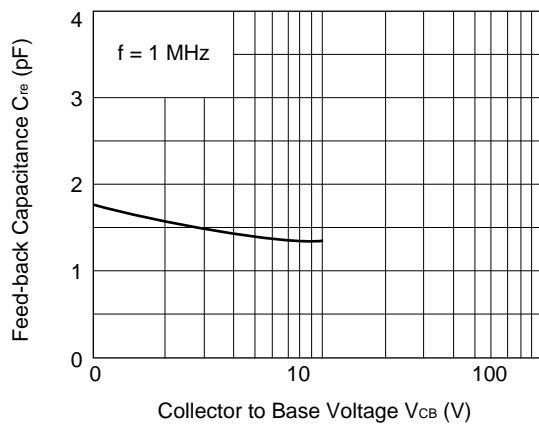

S PARAMETER

V<sub>CE</sub> = 1 V, I<sub>c</sub> = 1 mA

FREQUENCY f (MHz)	S <sub>11</sub>		S <sub>21</sub>		S <sub>12</sub>		S <sub>22</sub>	
	MAG	ANG	MAG	ANG	MAG	ANG	MAG	ANG
100.00	0.963	-8.3	3.846	172.1	0.013	74.6	0.913	-7.1
200.00	0.950	-16.3	3.745	164.4	0.026	73.7	0.907	-12.4
300.00	0.930	-24.1	3.656	156.0	0.037	69.1	0.911	-17.6
400.00	0.910	-31.4	3.531	148.9	0.050	64.7	0.908	-23.0
500.00	0.888	-38.6	3.428	143.4	0.060	60.4	0.911	-27.4
600.00	0.866	-45.2	3.272	137.3	0.070	55.7	0.911	-31.7
700.00	0.845	-51.3	3.144	131.8	0.078	51.0	0.899	-35.6
800.00	0.824	-57.0	2.999	126.6	0.085	46.9	0.883	-38.7
900.00	0.803	-62.4	2.880	121.3	0.089	42.7	0.874	-41.9
1000.00	0.779	-67.8	2.769	116.8	0.097	39.8	0.853	-44.9
1100.00	0.757	-72.6	2.654	112.4	0.101	36.8	0.833	-46.9
1200.00	0.731	-77.3	2.546	108.0	0.105	33.2	0.820	-49.5
1300.00	0.706	-81.8	2.467	103.9	0.109	30.1	0.806	-52.5
1400.00	0.682	-86.1	2.376	100.5	0.112	27.3	0.789	-54.4
1500.00	0.656	-90.6	2.295	96.6	0.114	24.8	0.776	-56.8
1600.00	0.633	-95.2	2.249	93.2	0.116	22.4	0.765	-59.2
1700.00	0.609	-100.1	2.195	89.7	0.119	20.3	0.751	-61.0
1800.00	0.588	-105.2	2.151	85.9	0.120	17.9	0.744	-63.0
1900.00	0.566	-111.0	2.123	81.8	0.122	15.3	0.732	-65.6
2000.00	0.547	-117.5	2.093	77.8	0.124	12.9	0.714	-67.5
2100.00	0.530	-124.4	2.045	73.6	0.125	9.8	0.706	-69.7
2200.00	0.512	-131.6	1.994	68.7	0.123	7.2	0.685	-72.5
2300.00	0.496	-139.4	1.941	64.0	0.124	4.9	0.668	-75.5
2400.00	0.485	-146.6	1.875	59.7	0.121	2.7	0.653	-78.0
2500.00	0.475	-153.4	1.795	55.6	0.118	0.1	0.641	-81.6
2600.00	0.469	-159.7	1.717	51.6	0.115	-1.7	0.621	-85.2
2700.00	0.469	-165.0	1.652	48.0	0.113	-3.2	0.622	-88.2
2800.00	0.469	-169.9	1.586	45.1	0.110	-4.9	0.618	-92.4
2900.00	0.471	-173.9	1.510	41.9	0.107	-6.2	0.615	-95.9
3000.00	0.477	-177.5	1.466	38.6	0.103	-7.6	0.622	-99.2

V<sub>CE</sub> = 1 V, I<sub>c</sub> = 3 mA

FREQUENCY f (MHz)	S <sub>11</sub>		S <sub>21</sub>		S <sub>12</sub>		S <sub>22</sub>	
	MAG	ANG	MAG	ANG	MAG	ANG	MAG	ANG
100.00	0.906	-12.6	9.595	169.0	0.013	72.7	0.888	-9.8
200.00	0.879	-24.3	9.124	158.8	0.024	70.1	0.869	-17.6
300.00	0.837	-35.6	8.660	148.3	0.035	64.4	0.856	-24.7
400.00	0.796	-45.9	8.156	139.6	0.044	59.6	0.830	-32.8
500.00	0.755	-55.7	7.668	133	0.053	53.3	0.816	-37.1
600.00	0.718	-64.0	7.087	126.2	0.059	48.9	0.800	-42.1
700.00	0.683	-71.6	6.629	120.2	0.064	44.7	0.769	-46.3
800.00	0.649	-78.3	6.17	114.8	0.068	41.2	0.736	-48.9
900.00	0.619	-84.5	5.773	109.3	0.071	38.5	0.722	-51.8
1000.00	0.586	-91.1	5.405	104.9	0.075	35.7	0.690	-55.0
1100.00	0.557	-96.2	5.085	100.7	0.078	33.6	0.661	-56.3
1200.00	0.528	-101.4	4.789	96.6	0.080	31.6	0.648	-58.4
1300.00	0.500	-106.7	4.553	92.6	0.081	29.2	0.626	-61.6
1400.00	0.476	-111.7	4.320	89.5	0.082	27.6	0.607	-62.4
1500.00	0.452	-116.8	4.106	85.9	0.082	26.4	0.597	-64.5
1600.00	0.429	-122.6	3.954	82.5	0.084	25.1	0.584	-66.9
1700.00	0.410	-128.6	3.801	79.3	0.086	24.6	0.570	-68.1
1800.00	0.393	-135.0	3.661	75.7	0.086	23.8	0.563	-69.6
1900.00	0.377	-142.4	3.545	72.0	0.087	22.5	0.549	-72.4
2000.00	0.367	-150.0	3.42	68.4	0.088	21.9	0.530	-73.7
2100.00	0.361	-157.8	3.290	65.0	0.088	20.4	0.521	-75.7
2200.00	0.356	-165.9	3.156	60.9	0.089	19.3	0.502	-78.5
2300.00	0.356	-173.4	3.023	57.4	0.088	18.7	0.483	-81.3
2400.00	0.363	179.8	2.893	54.0	0.088	18.1	0.471	-83.6
2500.00	0.364	174.0	2.759	50.9	0.088	17.2	0.463	-87.6
2600.00	0.373	169.4	2.629	48.0	0.086	17.1	0.444	-91.3
2700.00	0.384	165.3	2.528	45.1	0.086	16.9	0.447	-94.1
2800.00	0.391	161.9	2.434	42.9	0.086	16.9	0.447	-98.8
2900.00	0.401	159.0	2.319	40.4	0.086	16.7	0.445	-102.2
3000.00	0.412	156.3	2.254	37.4	0.086	17.0	0.455	-105.3

S PARAMETER

V<sub>CE</sub> = 1 V, I<sub>c</sub> = 5 mA

FREQUENCY f (MHz)	S <sub>11</sub>		S <sub>21</sub>		S <sub>12</sub>		S <sub>22</sub>	
	MAG	ANG	MAG	ANG	MAG	ANG	MAG	ANG
100.00	0.854	-16.4	14.321	166.4	0.012	71.0	0.870	-12.1
200.00	0.814	-31.4	13.342	154.2	0.023	67.0	0.839	-21.6
300.00	0.756	-45.1	12.322	142.3	0.032	61.4	0.811	-30.2
400.00	0.707	-57.6	11.306	132.6	0.041	55.8	0.773	-38.7
500.00	0.651	-69.0	10.34	125.5	0.047	50.4	0.742	-43.7
600.00	0.611	-78.5	9.368	118.6	0.052	46.0	0.712	-48.6
700.00	0.575	-86.8	8.582	112.8	0.055	42.3	0.676	-52.4
800.00	0.538	-93.6	7.849	107.5	0.058	39.7	0.640	-54.9
900.00	0.509	-100.2	7.236	102.2	0.059	37.3	0.620	-56.9
1000.00	0.479	-107.2	6.681	98.2	0.063	36.4	0.588	-59.9
1100.00	0.454	-112.5	6.221	94.3	0.064	35.0	0.562	-60.9
1200.00	0.426	-117.9	5.802	90.5	0.066	33.8	0.547	-62.5
1300.00	0.403	-123.4	5.473	86.8	0.067	32.8	0.528	-65.0
1400.00	0.385	-129	5.168	83.8	0.069	31.9	0.510	-65.6
1500.00	0.364	-134.6	4.881	80.5	0.070	31.7	0.503	-67.2
1600.00	0.348	-140.9	4.658	77.3	0.071	31.4	0.493	-69.4
1700.00	0.335	-147.7	4.452	74.2	0.072	31.0	0.481	-70.0
1800.00	0.325	-154.7	4.259	70.9	0.074	30.5	0.477	-71.9
1900.00	0.317	-162.5	4.083	67.4	0.075	30.0	0.465	-74.3
2000.00	0.315	-170.3	3.923	64.2	0.077	29.7	0.447	-75.8
2100.00	0.318	-177.6	3.750	61.1	0.078	29.2	0.440	-77.5
2200.00	0.322	175.1	3.576	57.6	0.078	29.0	0.423	-80.3
2300.00	0.331	168.2	3.414	54.4	0.080	28.6	0.407	-83.2
2400.00	0.341	163.0	3.257	51.4	0.080	28.3	0.396	-85.7
2500.00	0.350	158.3	3.105	48.8	0.081	27.9	0.388	-90.0
2600.00	0.362	154.5	2.957	46.2	0.082	28.1	0.373	-94.0
2700.00	0.375	151.9	2.847	43.6	0.083	28.2	0.376	-96.9
2800.00	0.386	149.2	2.742	41.7	0.084	27.9	0.378	-101.9
2900.00	0.396	146.8	2.615	39.3	0.086	28.0	0.378	-105.6
3000.00	0.408	145.1	2.542	36.6	0.086	28.1	0.389	-108.5

V<sub>CE</sub> = 1 V, I<sub>c</sub> = 10 mA

FREQUENCY f (MHz)	S <sub>11</sub>		S <sub>21</sub>		S <sub>12</sub>		S <sub>22</sub>	
	MAG	ANG	MAG	ANG	MAG	ANG	MAG	ANG
100.00	0.744	-24.6	22.615	161.3	0.012	68.1	0.826	-16.3
200.00	0.682	-46.1	20.113	145.6	0.021	62.6	0.769	-28.7
300.00	0.610	-64.7	17.536	132.0	0.028	57.4	0.710	-38.7
400.00	0.551	-79.7	15.292	121.5	0.033	49.1	0.654	-47.6
500.00	0.502	-93.2	13.319	114.5	0.038	47.6	0.610	-52.1
600.00	0.469	-104.1	11.724	107.9	0.041	44.6	0.573	-56.1
700.00	0.443	-112.5	10.485	102.8	0.043	43.3	0.538	-59.0
800.00	0.416	-119.8	9.391	98.1	0.045	41.4	0.506	-60.3
900.00	0.392	-126.2	8.510	93.3	0.046	41.3	0.491	-61.4
1000.00	0.375	-133.6	7.749	89.8	0.049	41.5	0.463	-63.6
1100.00	0.357	-138.8	7.146	86.5	0.050	41.7	0.441	-64.0
1200.00	0.338	-144.3	6.605	83.2	0.054	42.0	0.433	-64.9
1300.00	0.324	-150.3	6.181	79.9	0.055	41.7	0.419	-66.9
1400.00	0.314	-156.1	5.801	77.1	0.057	41.4	0.405	-66.9
1500.00	0.302	-162.0	5.450	74.1	0.058	41.3	0.404	-68.1
1600.00	0.295	-168.6	5.169	71.3	0.061	42.0	0.397	-70.2
1700.00	0.293	-175.3	4.902	68.4	0.064	41.5	0.390	-71.1
1800.00	0.293	178.1	4.662	65.4	0.065	41.9	0.388	-72.3
1900.00	0.296	170.9	4.445	62.2	0.067	41.6	0.382	-74.8
2000.00	0.304	164.5	4.234	59.3	0.069	41.5	0.366	-76.1
2100.00	0.313	158.7	4.031	56.6	0.071	41.0	0.361	-77.9
2200.00	0.323	153.4	3.828	53.5	0.073	40.7	0.348	-80.9
2300.00	0.339	148.6	3.639	50.7	0.076	40.3	0.333	-83.9
2400.00	0.352	145.3	3.470	48.1	0.077	40.7	0.323	-86.7
2500.00	0.363	141.9	3.312	45.9	0.079	40.1	0.319	-91.7
2600.00	0.378	139.9	3.151	43.7	0.081	40.6	0.306	-96.4
2700.00	0.392	138.2	3.036	41.4	0.084	39.6	0.310	-99.6
2800.00	0.404	136.5	2.930	39.8	0.085	39.3	0.317	-105.0
2900.00	0.414	134.9	2.798	37.6	0.088	38.9	0.317	-108.9
3000.00	0.426	133.6	2.723	35.0	0.089	38.7	0.330	-112.1

S PARAMETER

V<sub>CE</sub> = 1 V, I<sub>c</sub> = 15 mA

FREQUENCY f (MHz)	S <sub>11</sub>		S <sub>21</sub>		S <sub>12</sub>		S <sub>22</sub>	
	MAG	ANG	MAG	ANG	MAG	ANG	MAG	ANG
100.00	0.653	-33.1	27.337	156.8	0.011	68.9	0.789	-18.9
200.00	0.584	-60.3	23.208	138.8	0.019	60.2	0.707	-32.8
300.00	0.515	-82.1	19.335	124.9	0.024	53.7	0.632	-42.7
400.00	0.469	-99.2	16.289	114.6	0.029	48.3	0.569	-54.0
500.00	0.435	-112.6	13.817	107.9	0.032	47.2	0.519	-54.2
600.00	0.416	-123.1	11.97	101.7	0.035	45.4	0.502	-56.7
700.00	0.398	-131.1	10.579	97.1	0.037	46.6	0.468	-59.8
800.00	0.378	-138	9.386	92.7	0.039	45.9	0.439	-58.5
900.00	0.362	-144.1	8.451	88.3	0.040	45.7	0.442	-59.7
1000.00	0.354	-151.1	7.653	85.3	0.043	46.9	0.411	-62.5
1100.00	0.339	-156.1	7.023	82.1	0.046	47.0	0.396	-61.2
1200.00	0.325	-161.5	6.475	79.1	0.048	47.6	0.396	-62.6
1300.00	0.317	-167.1	6.041	76.0	0.050	47.8	0.379	-64.9
1400.00	0.311	-172.3	5.649	73.3	0.053	47.4	0.373	-63.9
1500.00	0.304	-178.0	5.304	70.5	0.054	47.5	0.376	-65.7
1600.00	0.302	175.6	5.012	67.8	0.057	47.9	0.370	-67.9
1700.00	0.304	170	4.745	65.0	0.060	47.8	0.365	-68.2
1800.00	0.307	164.1	4.500	62.1	0.062	47.7	0.367	-69.8
1900.00	0.314	158.0	4.276	59.2	0.065	47.4	0.358	-72.4
2000.00	0.325	152.9	4.068	56.3	0.068	47.4	0.346	-73.3
2100.00	0.335	148.2	3.864	53.8	0.069	47.1	0.345	-75.4
2200.00	0.347	143.9	3.666	50.8	0.072	46.3	0.329	-78.7
2300.00	0.362	140.2	3.481	48.3	0.074	46.3	0.317	-81.4
2400.00	0.375	137.6	3.318	45.8	0.077	45.8	0.311	-84.5
2500.00	0.386	135.1	3.159	43.7	0.079	45.5	0.304	-89.9
2600.00	0.402	133.7	3.010	41.7	0.081	44.8	0.292	-94.3
2700.00	0.416	132.5	2.901	39.5	0.084	44.7	0.299	-97.8
2800.00	0.427	131.2	2.801	37.9	0.086	44.4	0.303	-104.0
2900.00	0.439	129.8	2.676	35.9	0.089	43.4	0.304	-107.7
3000.00	0.449	128.7	2.603	33.3	0.091	42.7	0.319	-111.0

V<sub>CE</sub> = 2 V, I<sub>c</sub> = 1 mA

FREQUENCY f (MHz)	S <sub>11</sub>		S <sub>21</sub>		S <sub>12</sub>		S <sub>22</sub>	
	MAG	ANG	MAG	ANG	MAG	ANG	MAG	ANG
100.00	0.965	-7.7	3.924	172.5	0.010	73.8	0.913	-6.6
200.00	0.953	-15.2	3.823	165.1	0.019	73.5	0.904	-11.6
300.00	0.935	-22.6	3.733	157.0	0.028	71.0	0.908	-16.1
400.00	0.916	-29.3	3.631	150.0	0.037	65.6	0.897	-23.3
500.00	0.897	-36.1	3.522	145.2	0.045	62.1	0.904	-24.6
600.00	0.877	-42.3	3.381	139.4	0.053	57.2	0.922	-28.6
700.00	0.859	-48.2	3.256	134.4	0.060	53.5	0.907	-31.9
800.00	0.839	-53.5	3.108	129.5	0.065	49.8	0.892	-33.9
900.00	0.820	-58.7	2.999	124.1	0.069	46.2	0.896	-37.6
1000.00	0.796	-64.0	2.901	119.7	0.075	43.1	0.874	-40.6
1100.00	0.775	-68.5	2.791	115.6	0.079	40.2	0.860	-41.7
1200.00	0.751	-72.9	2.674	111.4	0.081	36.9	0.852	-44.6
1300.00	0.726	-77.3	2.604	107.2	0.085	33.5	0.836	-47.6
1400.00	0.702	-81.4	2.514	104.0	0.087	31.4	0.824	-48.9
1500.00	0.677	-85.6	2.430	100.1	0.089	28.5	0.815	-51.4
1600.00	0.653	-89.9	2.383	96.7	0.090	26.4	0.800	-53.9
1700.00	0.629	-94.5	2.332	93.4	0.092	24.4	0.790	-55.2
1800.00	0.607	-99.3	2.289	89.9	0.093	22.6	0.788	-57.1
1900.00	0.584	-104.7	2.263	85.8	0.094	19.9	0.772	-59.7
2000.00	0.564	-110.6	2.237	82.0	0.095	17.7	0.759	-61.2
2100.00	0.545	-117.4	2.194	77.8	0.095	15.8	0.755	-63.4
2200.00	0.526	-124.3	2.145	73.0	0.095	13.1	0.732	-66.0
2300.00	0.508	-131.7	2.099	68.4	0.094	11.0	0.719	-68.6
2400.00	0.495	-139.3	2.032	64.0	0.092	9.1	0.706	-71.1
2500.00	0.481	-145.9	1.951	59.9	0.090	7.1	0.692	-74.6
2600.00	0.476	-152.2	1.869	55.8	0.087	5.0	0.673	-77.9
2700.00	0.471	-158.2	1.801	52.0	0.086	4.3	0.676	-80.9
2800.00	0.469	-162.9	1.733	49.1	0.083	2.7	0.669	-85.1
2900.00	0.472	-167.3	1.647	45.7	0.080	2.7	0.664	-88.4
3000.00	0.476	-171.4	1.602	42.3	0.077	1.6	0.672	-92.0

S PARAMETER

V<sub>CE</sub> = 2 V, I<sub>c</sub> = 3 mA

FREQUENCY		S <sub>11</sub>		S <sub>21</sub>		S <sub>12</sub>		S <sub>22</sub>	
f (MHz)	MAG	ANG	MAG	ANG	MAG	ANG	MAG	ANG	
100.00	0.911	-11.3	9.673	169.8	0.010	71.9	0.897	-8.5	
200.00	0.887	-21.9	9.244	160.1	0.018	70.9	0.879	-15.2	
300.00	0.850	-32.2	8.830	150.1	0.026	66.0	0.871	-21.4	
400.00	0.814	-41.3	8.390	141.6	0.034	60.2	0.849	-29.3	
500.00	0.776	-50.5	7.920	135.5	0.041	56.0	0.838	-31.9	
600.00	0.741	-58.3	7.389	129.0	0.046	52.4	0.835	-36.3	
700.00	0.708	-65.5	6.948	123.4	0.050	47.8	0.806	-39.9	
800.00	0.675	-71.6	6.492	118.1	0.053	44.6	0.778	-41.9	
900.00	0.645	-77.5	6.113	112.5	0.055	42.3	0.772	-45.1	
1000.00	0.610	-83.8	5.754	108.0	0.060	39.1	0.739	-48.0	
1100.00	0.583	-88.8	5.437	103.9	0.061	37.5	0.716	-48.7	
1200.00	0.552	-93.5	5.127	99.8	0.063	35.1	0.705	-51.0	
1300.00	0.523	-98.5	4.899	95.7	0.064	33.2	0.684	-53.8	
1400.00	0.497	-103.2	4.663	92.6	0.065	32.2	0.669	-54.5	
1500.00	0.470	-107.8	4.431	88.9	0.065	30.8	0.660	-56.4	
1600.00	0.445	-112.9	4.267	85.7	0.066	30.2	0.646	-58.7	
1700.00	0.421	-118.7	4.112	82.5	0.067	30.0	0.634	-59.7	
1800.00	0.402	-124.5	3.974	79.2	0.068	29.0	0.630	-61.1	
1900.00	0.382	-131.2	3.854	75.4	0.068	28.1	0.615	-63.6	
2000.00	0.368	-138.7	3.734	72.0	0.069	27.3	0.601	-64.6	
2100.00	0.356	-146.3	3.605	68.5	0.070	26.5	0.593	-66.4	
2200.00	0.348	-154.2	3.462	64.5	0.069	25.9	0.574	-68.9	
2300.00	0.344	-162.6	3.340	60.7	0.070	26.0	0.558	-71.1	
2400.00	0.346	-169.5	3.200	57.3	0.070	25.7	0.548	-73.4	
2500.00	0.347	-175.9	3.058	54.1	0.069	25.1	0.535	-76.9	
2600.00	0.354	178.6	2.919	50.9	0.068	25.5	0.517	-80.0	
2700.00	0.363	174.0	2.810	48.0	0.070	26.0	0.520	-83.0	
2800.00	0.370	170.2	2.709	45.7	0.070	25.9	0.516	-87.4	
2900.00	0.379	166.7	2.580	42.9	0.070	27.0	0.512	-90.6	
3000.00	0.390	163.8	2.511	40.0	0.070	26.7	0.523	-94.0	

V<sub>CE</sub> = 2 V, I<sub>c</sub> = 5 mA

FREQUENCY		S <sub>11</sub>		S <sub>21</sub>		S <sub>12</sub>		S <sub>22</sub>	
f (MHz)	MAG	ANG	MAG	ANG	MAG	ANG	MAG	ANG	
100.00	0.863	-14.2	14.231	167.6	0.009	73.5	0.883	-10.1	
200.00	0.829	-27.3	13.388	156.2	0.017	70.1	0.854	-18.2	
300.00	0.775	-39.8	12.53	144.8	0.025	62.3	0.834	-25.1	
400.00	0.726	-50.9	11.653	134.8	0.031	58.0	0.797	-34.7	
500.00	0.679	-61.2	10.679	128.6	0.036	53.6	0.770	-36.4	
600.00	0.638	-70.1	9.807	122.0	0.041	49.6	0.763	-40.6	
700.00	0.604	-77.9	9.125	116.6	0.044	46.2	0.727	-44.2	
800.00	0.570	-84.3	8.384	111.4	0.046	43.5	0.697	-45.1	
900.00	0.536	-90.2	7.775	105.7	0.047	41.5	0.690	-48.1	
1000.00	0.501	-97.3	7.215	101.4	0.050	39.5	0.653	-51.0	
1100.00	0.474	-102.2	6.753	97.5	0.051	39.1	0.633	-51.1	
1200.00	0.445	-107	6.294	93.6	0.052	38.0	0.624	-53.1	
1300.00	0.418	-112.0	5.954	89.8	0.054	36.6	0.600	-55.7	
1400.00	0.396	-117.3	5.634	86.8	0.055	36.1	0.588	-55.8	
1500.00	0.372	-122.3	5.328	83.5	0.056	35.9	0.582	-57.6	
1600.00	0.351	-128.1	5.089	80.3	0.056	36.0	0.568	-59.6	
1700.00	0.334	-134.5	4.875	77.2	0.059	35.6	0.559	-60.3	
1800.00	0.318	-141.0	4.672	74.0	0.060	36.6	0.559	-61.7	
1900.00	0.305	-148.6	4.493	70.6	0.060	35.3	0.543	-64.0	
2000.00	0.298	-156.9	4.327	67.3	0.061	35.3	0.531	-64.7	
2100.00	0.296	-164.7	4.145	64.2	0.063	35.2	0.527	-66.6	
2200.00	0.295	-172.5	3.970	60.6	0.063	35.5	0.507	-69.1	
2300.00	0.300	179.7	3.806	57.4	0.065	35.1	0.493	-71.0	
2400.00	0.309	173.5	3.644	54.3	0.066	36.2	0.484	-73.4	
2500.00	0.316	167.8	3.483	51.5	0.066	35.5	0.471	-77.2	
2600.00	0.329	163.7	3.324	48.7	0.068	35.4	0.455	-80.4	
2700.00	0.341	160.0	3.200	46.0	0.069	36.0	0.457	-83.3	
2800.00	0.352	156.9	3.083	44.0	0.069	36.4	0.455	-88.0	
2900.00	0.362	154.2	2.942	41.4	0.072	36.7	0.453	-91.3	
3000.00	0.374	152	2.859	38.6	0.073	36.8	0.464	-94.6	

S PARAMETER

V<sub>CE</sub> = 2 V, I<sub>c</sub> = 10 mA

FREQUENCY f (MHz)	S <sub>11</sub>		S <sub>21</sub>		S <sub>12</sub>		S <sub>22</sub>	
	MAG	ANG	MAG	ANG	MAG	ANG	MAG	ANG
100.00	0.760	-20.5	22.891	163.4	0.009	68.3	0.850	-13.1
200.00	0.707	-38.8	20.801	149.0	0.016	65.3	0.802	-23.2
300.00	0.635	-55.2	18.567	135.9	0.022	59.9	0.755	-31.3
400.00	0.573	-68.8	16.493	125.5	0.027	55.4	0.701	-41.4
500.00	0.525	-81.1	14.602	118.5	0.029	51.6	0.661	-42.3
600.00	0.487	-91.1	12.974	111.7	0.033	48.2	0.646	-45.6
700.00	0.454	-99.3	11.679	106.3	0.035	47.4	0.608	-48.6
800.00	0.423	-106.0	10.503	101.4	0.036	45.6	0.578	-48.3
900.00	0.394	-112.2	9.577	96.4	0.037	45.2	0.578	-50.4
1000.00	0.372	-119.9	8.728	92.8	0.040	45.4	0.541	-52.9
1100.00	0.350	-124.7	8.056	89.3	0.042	45.3	0.525	-52.1
1200.00	0.327	-130.0	7.452	85.9	0.044	45.0	0.522	-53.7
1300.00	0.309	-135.6	6.989	82.6	0.045	45.1	0.502	-55.7
1400.00	0.294	-141.1	6.557	79.8	0.046	46.3	0.494	-55.2
1500.00	0.278	-147.1	6.163	76.8	0.048	46.6	0.494	-57.0
1600.00	0.266	-153.7	5.857	74	0.050	46.6	0.484	-58.8
1700.00	0.258	-160.8	5.563	71.1	0.052	46.4	0.478	-59.2
1800.00	0.253	-168.0	5.301	68.2	0.054	47.4	0.480	-60.6
1900.00	0.250	-176.1	5.062	65.1	0.055	47.1	0.469	-62.8
2000.00	0.256	176.5	4.840	62.3	0.057	46.6	0.459	-63.4
2100.00	0.261	169.5	4.619	59.5	0.059	47.6	0.457	-65.1
2200.00	0.272	163	4.396	56.4	0.061	48.0	0.439	-67.8
2300.00	0.284	157.2	4.200	53.7	0.063	47.2	0.426	-69.7
2400.00	0.298	153.0	4.008	51.0	0.065	47.1	0.419	-72.2
2500.00	0.310	149.0	3.831	48.6	0.067	46.8	0.408	-76.2
2600.00	0.327	146.5	3.667	46.2	0.068	47.8	0.391	-79.6
2700.00	0.341	144.5	3.531	43.9	0.071	46.6	0.396	-82.8
2800.00	0.354	142.3	3.411	42.1	0.073	46.7	0.394	-87.9
2900.00	0.365	140.4	3.261	39.7	0.076	46.6	0.392	-91.4
3000.00	0.377	139.0	3.170	37.0	0.077	46.0	0.404	-94.9

V<sub>CE</sub> = 2 V, I<sub>c</sub> = 15 mA

FREQUENCY f (MHz)	S <sub>11</sub>		S <sub>21</sub>		S <sub>12</sub>		S <sub>22</sub>	
	MAG	ANG	MAG	ANG	MAG	ANG	MAG	ANG
100.00	0.679	-25.8	28.477	160.2	0.008	72.4	0.827	-15.3
200.00	0.616	-48.2	25.048	143.8	0.015	63.0	0.760	-26.4
300.00	0.543	-67.2	21.555	130	0.020	59.2	0.697	-34.5
400.00	0.485	-82.1	18.572	119.4	0.024	54.7	0.638	-45.2
500.00	0.443	-95.5	16.03	112.6	0.026	52.2	0.592	-44.4
600.00	0.413	-106.3	14.018	106.1	0.028	50.1	0.581	-46.9
700.00	0.388	-114.4	12.469	101.2	0.031	49.1	0.545	-49.5
800.00	0.362	-121.0	11.102	96.6	0.032	49.8	0.521	-48.2
900.00	0.340	-127.1	10.046	91.8	0.034	49.3	0.526	-50.1
1000.00	0.327	-135.1	9.107	88.7	0.037	50.3	0.490	-52.3
1100.00	0.308	-139.8	8.375	85.5	0.039	50.0	0.479	-51.0
1200.00	0.289	-145.3	7.719	82.2	0.039	51.0	0.480	-52.6
1300.00	0.276	-151.2	7.219	79.0	0.041	49.4	0.462	-54.7
1400.00	0.267	-156.7	6.754	76.5	0.044	51.9	0.458	-53.9
1500.00	0.255	-162.9	6.336	73.6	0.046	52.0	0.460	-55.6
1600.00	0.248	-169.6	5.997	70.9	0.047	52.5	0.452	-57.5
1700.00	0.246	-176.4	5.681	68.1	0.050	52.5	0.449	-57.7
1800.00	0.245	176.8	5.397	65.4	0.052	53.1	0.452	-59.1
1900.00	0.249	169.4	5.148	62.4	0.054	52.9	0.443	-61.5
2000.00	0.259	163.0	4.910	59.7	0.056	52.7	0.432	-62.1
2100.00	0.268	157.1	4.675	57.1	0.059	52.7	0.433	-63.8
2200.00	0.279	151.8	4.445	54.2	0.061	52.5	0.416	-66.5
2300.00	0.295	147.2	4.237	51.7	0.063	51.9	0.404	-68.4
2400.00	0.309	144.4	4.048	49.1	0.066	52.5	0.397	-71.0
2500.00	0.323	141.1	3.865	46.8	0.068	51.3	0.386	-75.4
2600.00	0.339	139.2	3.696	44.6	0.070	50.9	0.372	-79.0
2700.00	0.353	137.8	3.564	42.4	0.073	51.4	0.375	-82.1
2800.00	0.366	136.1	3.444	40.7	0.076	50.7	0.373	-87.7
2900.00	0.378	134.7	3.292	38.4	0.078	49.8	0.373	-91.2
3000.00	0.391	133.6	3.204	35.8	0.080	49.4	0.385	-94.8



S PARAMETER

V<sub>CE</sub> = 3 V, I<sub>c</sub> = 1 mA

FREQUENCY f (MHz)	S <sub>11</sub>		S <sub>21</sub>		S <sub>12</sub>		S <sub>22</sub>	
	MAG	ANG	MAG	ANG	MAG	ANG	MAG	ANG
100.00	0.966	-7.5	3.757	172.7	0.009	75.8	0.915	-6.3
200.00	0.956	-14.6	3.683	165.5	0.017	75.1	0.907	-11.1
300.00	0.938	-21.7	3.614	157.6	0.024	72.4	0.911	-15.3
400.00	0.923	-28.3	3.504	150.5	0.034	68.1	0.903	-21.7
500.00	0.904	-34.8	3.399	146.0	0.040	62.9	0.912	-23.6
600.00	0.885	-40.9	3.283	140.4	0.047	58.2	0.929	-27.4
700.00	0.869	-46.6	3.171	135.6	0.054	54.7	0.915	-30.6
800.00	0.850	-51.8	3.024	130.6	0.058	51.5	0.902	-32.6
900.00	0.833	-56.9	2.920	125.3	0.061	46.7	0.907	-36.2
1000.00	0.809	-62.0	2.842	121.0	0.068	44.7	0.887	-39.0
1100.00	0.789	-66.5	2.731	117.0	0.071	41.1	0.873	-40.0
1200.00	0.765	-70.8	2.627	112.7	0.074	38.4	0.867	-42.8
1300.00	0.741	-75.1	2.561	108.4	0.076	35.1	0.852	-45.8
1400.00	0.718	-79.3	2.475	105.3	0.079	32.4	0.841	-47.2
1500.00	0.692	-83.3	2.395	101.5	0.079	30.0	0.832	-49.6
1600.00	0.668	-87.4	2.345	98.1	0.081	27.6	0.819	-52.1
1700.00	0.645	-91.9	2.306	94.8	0.083	25.8	0.810	-53.3
1800.00	0.622	-96.6	2.266	91.2	0.084	24.5	0.807	-55.2
1900.00	0.601	-101.6	2.238	87.4	0.085	21.8	0.793	-57.7
2000.00	0.579	-107.7	2.219	83.4	0.085	19.3	0.782	-59.2
2100.00	0.560	-114.0	2.178	79.3	0.086	17.1	0.778	-61.3
2200.00	0.540	-121.0	2.139	74.4	0.085	14.8	0.757	-63.9
2300.00	0.520	-128.3	2.097	69.7	0.085	13.0	0.743	-66.5
2400.00	0.507	-135.6	2.036	65.4	0.082	11.1	0.733	-68.9
2500.00	0.492	-142.6	1.955	61.1	0.081	9.0	0.718	-72.4
2600.00	0.483	-148.9	1.876	56.9	0.078	7.9	0.698	-75.7
2700.00	0.479	-154.8	1.809	53.1	0.075	6.5	0.701	-78.4
2800.00	0.476	-159.9	1.736	50.0	0.074	5.5	0.695	-82.8
2900.00	0.475	-164.4	1.658	46.6	0.071	6.0	0.690	-86.1
3000.00	0.480	-168.4	1.610	43.1	0.067	4.2	0.699	-89.7

V<sub>CE</sub> = 3 V, I<sub>c</sub> = 3 mA

FREQUENCY f (MHz)	S <sub>11</sub>		S <sub>21</sub>		S <sub>12</sub>		S <sub>22</sub>	
	MAG	ANG	MAG	ANG	MAG	ANG	MAG	ANG
100.00	0.913	-10.8	9.727	170.1	0.009	74.5	0.901	-8.1
200.00	0.891	-21.0	9.304	160.6	0.016	72.6	0.883	-14.5
300.00	0.853	-31.0	8.914	150.8	0.024	65.6	0.877	-20.2
400.00	0.818	-39.9	8.480	142.2	0.031	62.3	0.854	-27.9
500.00	0.783	-48.7	8.034	136.4	0.036	56.5	0.846	-30.2
600.00	0.750	-56.4	7.520	129.9	0.041	53.3	0.845	-34.4
700.00	0.718	-63.3	7.095	124.4	0.045	48.8	0.819	-37.9
800.00	0.685	-69.3	6.629	119.1	0.048	46.0	0.792	-39.6
900.00	0.656	-75.2	6.256	113.4	0.050	43.9	0.789	-42.9
1000.00	0.620	-81.4	5.911	109.0	0.054	40.7	0.757	-45.7
1100.00	0.592	-86.1	5.585	104.9	0.054	38.8	0.735	-46.2
1200.00	0.561	-90.8	5.267	100.8	0.056	37.0	0.725	-48.6
1300.00	0.531	-95.5	5.035	96.8	0.058	34.7	0.704	-51.1
1400.00	0.506	-100.1	4.793	93.6	0.058	33.6	0.690	-51.9
1500.00	0.477	-104.7	4.567	90.1	0.059	33.2	0.682	-53.9
1600.00	0.451	-109.5	4.400	86.7	0.059	31.5	0.667	-56.0
1700.00	0.428	-115.1	4.240	83.5	0.060	31.8	0.657	-56.8
1800.00	0.406	-120.6	4.099	80.2	0.061	30.9	0.653	-58.3
1900.00	0.384	-127.0	3.979	76.5	0.062	30.8	0.639	-60.6
2000.00	0.368	-134.5	3.859	72.9	0.063	29.3	0.625	-61.4
2100.00	0.356	-141.8	3.729	69.5	0.063	29.7	0.622	-63.4
2200.00	0.345	-149.7	3.587	65.6	0.062	29.4	0.601	-65.6
2300.00	0.339	-158.2	3.465	61.8	0.063	29.4	0.587	-67.8
2400.00	0.339	-165.2	3.328	58.3	0.063	28.7	0.576	-70.1
2500.00	0.340	-171.8	3.181	55.0	0.063	28.5	0.563	-73.4
2600.00	0.346	-177.5	3.042	51.9	0.062	29.1	0.546	-76.5
2700.00	0.354	177.5	2.933	48.8	0.063	29.8	0.548	-79.2
2800.00	0.362	173.3	2.821	46.5	0.064	30.9	0.544	-83.7
2900.00	0.369	169.7	2.692	43.6	0.064	31.4	0.539	-87.0
3000.00	0.380	166.7	2.613	40.5	0.064	32.6	0.551	-90.5

S PARAMETER

V<sub>CE</sub> = 3 V, I<sub>c</sub> = 5 mA

FREQUENCY f (MHz)	S <sub>11</sub>		S <sub>21</sub>		S <sub>12</sub>		S <sub>22</sub>	
	MAG	ANG	MAG	ANG	MAG	ANG	MAG	ANG
100.00	0.868	-13.6	14.304	168	0.008	73.3	0.888	-9.5
200.00	0.836	-26.0	13.488	157.0	0.016	70.0	0.862	-16.9
300.00	0.787	-37.8	12.686	145.9	0.022	63.4	0.844	-23.5
400.00	0.739	-48.9	11.834	136.5	0.029	58.7	0.810	-31.9
500.00	0.692	-58.4	10.961	130.0	0.032	55.3	0.789	-34.2
600.00	0.652	-66.9	10.065	123.3	0.037	50.6	0.780	-38.3
700.00	0.615	-74.5	9.332	117.6	0.040	47.6	0.748	-41.6
800.00	0.577	-80.8	8.595	112.3	0.041	45.4	0.717	-42.7
900.00	0.547	-86.7	7.987	106.7	0.042	43.0	0.715	-45.7
1000.00	0.511	-93.5	7.433	102.6	0.045	41.8	0.677	-48.2
1100.00	0.482	-98.2	6.951	98.6	0.047	40.8	0.656	-48.3
1200.00	0.452	-102.8	6.498	94.7	0.048	39.4	0.647	-50.1
1300.00	0.425	-107.9	6.154	91	0.049	38.6	0.626	-52.5
1400.00	0.402	-112.7	5.820	88.0	0.050	37.6	0.614	-52.9
1500.00	0.376	-117.5	5.501	84.6	0.050	38.4	0.609	-54.5
1600.00	0.354	-122.9	5.268	81.6	0.052	38.1	0.595	-56.4
1700.00	0.335	-129.2	5.044	78.5	0.053	37.7	0.587	-57.0
1800.00	0.318	-135.3	4.835	75.4	0.055	38.5	0.585	-58.5
1900.00	0.302	-142.7	4.654	71.9	0.055	38.4	0.573	-60.6
2000.00	0.293	-150.7	4.493	68.7	0.056	38.9	0.560	-61.2
2100.00	0.287	-158.7	4.312	65.7	0.056	38.2	0.557	-62.9
2200.00	0.285	-166.8	4.132	62.0	0.058	38.8	0.538	-65.3
2300.00	0.288	-175.0	3.971	58.7	0.059	39.3	0.524	-67.1
2400.00	0.295	178.6	3.805	55.7	0.061	39.2	0.515	-69.4
2500.00	0.302	172.5	3.635	52.9	0.061	40.1	0.502	-72.8
2600.00	0.314	167.9	3.473	50.0	0.062	40.3	0.486	-75.9
2700.00	0.326	164.0	3.352	47.3	0.063	40.5	0.489	-78.8
2800.00	0.337	160.6	3.227	45.2	0.065	40.6	0.487	-83.4
2900.00	0.348	157.8	3.083	42.6	0.066	41.4	0.482	-86.6
3000.00	0.359	155.3	2.995	39.6	0.066	40.9	0.493	-90.4

V<sub>CE</sub> = 3 V, I<sub>c</sub> = 10 mA

FREQUENCY f (MHz)	S <sub>11</sub>		S <sub>21</sub>		S <sub>12</sub>		S <sub>22</sub>	
	MAG	ANG	MAG	ANG	MAG	ANG	MAG	ANG
100.00	0.770	-19.0	23.007	164.0	0.008	71.6	0.859	-12.3
200.00	0.720	-36.3	21.033	150.1	0.014	65.7	0.815	-21.4
300.00	0.651	-51.8	18.926	137.2	0.020	60.5	0.772	-29.0
400.00	0.591	-65.4	16.929	126.9	0.023	58.0	0.723	-38.1
500.00	0.538	-76.5	15.047	119.9	0.028	51.9	0.688	-39.5
600.00	0.497	-86.2	13.422	113.1	0.030	50.0	0.671	-42.7
700.00	0.463	-94.1	12.12	107.8	0.032	48.7	0.635	-45.4
800.00	0.429	-100.5	10.911	102.9	0.034	46.7	0.607	-45.5
900.00	0.403	-107.3	9.888	97.6	0.034	47.1	0.607	-47.6
1000.00	0.373	-113.7	9.117	94.1	0.037	47.7	0.571	-49.7
1100.00	0.351	-118.4	8.414	90.6	0.038	46.7	0.554	-49.0
1200.00	0.326	-123.5	7.788	87.2	0.040	47.4	0.550	-50.5
1300.00	0.306	-128.9	7.309	83.8	0.041	47.0	0.533	-52.4
1400.00	0.289	-134.2	6.86	81.1	0.043	48.2	0.525	-52.1
1500.00	0.271	-139.8	6.445	78.1	0.044	48.0	0.525	-53.7
1600.00	0.256	-146.1	6.125	75.3	0.046	48.5	0.515	-55.4
1700.00	0.246	-153.3	5.819	72.5	0.048	49.4	0.510	-55.7
1800.00	0.238	-160.4	5.547	69.7	0.049	49.4	0.510	-56.9
1900.00	0.233	-168.9	5.312	66.7	0.051	49.7	0.501	-59.1
2000.00	0.236	-176.9	5.081	63.8	0.053	50.3	0.490	-59.7
2100.00	0.240	175.4	4.848	61.1	0.056	50.7	0.490	-61.2
2200.00	0.248	168.4	4.625	58.0	0.056	50.8	0.472	-63.7
2300.00	0.262	162.0	4.422	55.3	0.059	50.3	0.460	-65.5
2400.00	0.274	157.6	4.233	52.6	0.061	50.6	0.452	-67.9
2500.00	0.287	153.4	4.048	50.2	0.063	50.4	0.441	-71.7
2600.00	0.304	150.2	3.878	47.7	0.064	51.0	0.425	-74.9
2700.00	0.319	147.9	3.739	45.2	0.066	50.6	0.428	-77.9
2800.00	0.330	145.6	3.604	43.5	0.069	49.5	0.425	-82.8
2900.00	0.343	143.7	3.449	41.0	0.072	49.9	0.423	-86.2
3000.00	0.355	142.1	3.352	38.3	0.073	49.9	0.434	-90.1

S PARAMETER

V<sub>CE</sub> = 3 V, I<sub>c</sub> = 15 mA

FREQUENCY f (MHz)	S <sub>11</sub>		S <sub>21</sub>		S <sub>12</sub>		S <sub>22</sub>	
	MAG	ANG	MAG	ANG	MAG	ANG	MAG	ANG
100.00	0.695	-23.5	28.64	161.2	0.008	70.9	0.837	-13.9
200.00	0.636	-44.1	25.451	145.4	0.013	66.1	0.779	-24.0
300.00	0.558	-62.4	22.15	131.7	0.018	61.3	0.723	-31.8
400.00	0.506	-77.0	19.259	121.3	0.022	54.9	0.669	-40.9
500.00	0.453	-88.8	16.721	114.4	0.024	53.0	0.628	-41.3
600.00	0.419	-99.1	14.679	107.9	0.027	51.4	0.612	-44.0
700.00	0.390	-107.2	13.085	102.9	0.028	51.2	0.578	-46.2
800.00	0.363	-113.5	11.684	98.2	0.030	50.2	0.553	-45.7
900.00	0.341	-119.5	10.582	93.3	0.031	49.9	0.558	-47.7
1000.00	0.320	-127.1	9.608	90.2	0.034	52.1	0.524	-49.2
1100.00	0.301	-131.8	8.839	87.0	0.036	51.6	0.512	-48.2
1200.00	0.281	-137.3	8.148	83.7	0.037	52.7	0.510	-49.4
1300.00	0.264	-142.8	7.617	80.6	0.039	51.8	0.494	-51.3
1400.00	0.253	-148.4	7.143	78.0	0.041	54.4	0.490	-50.7
1500.00	0.239	-154.1	6.694	75.2	0.043	54.1	0.493	-52.3
1600.00	0.230	-161.3	6.345	72.5	0.045	53.4	0.484	-54.0
1700.00	0.225	-168.5	6.013	69.9	0.046	54.5	0.481	-54.4
1800.00	0.222	-175.5	5.711	67.1	0.049	55.4	0.484	-55.8
1900.00	0.223	176.4	5.455	64.2	0.050	55.4	0.474	-57.7
2000.00	0.230	169.3	5.211	61.5	0.052	55.5	0.466	-58.3
2100.00	0.239	162.7	4.965	59.0	0.055	55.1	0.466	-60.1
2200.00	0.251	156.7	4.733	56.1	0.057	55.2	0.449	-62.4
2300.00	0.266	151.6	4.517	53.5	0.060	54.6	0.439	-64.4
2400.00	0.281	148.1	4.313	51.0	0.063	56.0	0.430	-66.8
2500.00	0.293	145.0	4.130	48.7	0.063	54.9	0.419	-70.8
2600.00	0.310	142.7	3.952	46.5	0.066	55.3	0.404	-74.0
2700.00	0.326	141.1	3.807	44.2	0.068	54.7	0.408	-77.2
2800.00	0.338	139.3	3.680	42.4	0.070	54.0	0.404	-82.2
2900.00	0.350	137.8	3.517	40.2	0.073	53.7	0.403	-85.7
3000.00	0.364	136.6	3.430	37.5	0.075	53.3	0.412	-89.3

## [MEMO]

No part of this document may be copied or reproduced in any form or by any means without the prior written consent of NEC Corporation. NEC Corporation assumes no responsibility for any errors which may appear in this document.

NEC Corporation does not assume any liability for infringement of patents, copyrights or other intellectual property rights of third parties by or arising from use of a device described herein or any other liability arising from use of such device. No license, either express, implied or otherwise, is granted under any patents, copyrights or other intellectual property rights of NEC Corporation or others.

While NEC Corporation has been making continuous effort to enhance the reliability of its semiconductor devices, the possibility of defects cannot be eliminated entirely. To minimize risks of damage or injury to persons or property arising from a defect in an NEC semiconductor device, customers must incorporate sufficient safety measures in its design, such as redundancy, fire-containment, and anti-failure features.

NEC devices are classified into the following three quality grades:

"Standard", "Special", and "Specific". The Specific quality grade applies only to devices developed based on a customer designated "quality assurance program" for a specific application. The recommended applications of a device depend on its quality grade, as indicated below. Customers must check the quality grade of each device before using it in a particular application.

Standard: Computers, office equipment, communications equipment, test and measurement equipment, audio and visual equipment, home electronic appliances, machine tools, personal electronic equipment and industrial robots

Special: Transportation equipment (automobiles, trains, ships, etc.), traffic control systems, anti-disaster systems, anti-crime systems, safety equipment and medical equipment (not specifically designed for life support)

Specific: Aircrafts, aerospace equipment, submersible repeaters, nuclear reactor control systems, life support systems or medical equipment for life support, etc.

The quality grade of NEC devices is "Standard" unless otherwise specified in NEC's Data Sheets or Data Books. If customers intend to use NEC devices for applications other than those specified for Standard quality grade, they should contact an NEC sales representative in advance.

Anti-radioactive design is not implemented in this product.